

NAUTIZ K2

MANUAL



handheld

CONTENT

1. Introduction.....	4
1.1 Appearance of Nautiz X2.....	4
1.2 Installing the Battery.....	5
1.3 Removing the Battery.....	5
1.4 Inserting a SIM Card.....	6
1.5 Inserting a TF Card.....	6
1.6 Charging.....	7
2. Using the Nautiz X2.....	8
2.1 Powering On/Off the Nautiz X2.....	8
2.2 Locking and Unlocking the Nautiz X2.....	8
2.3 Keys.....	8
2.4 Home Screen.....	9
2.5 Status Icons and Indicators.....	10
2.6 Basic Settings.....	11
2.6.1 Date and Time Settings.....	11
2.6.2 Display Settings.....	12
2.6.3 Ringtone Settings.....	13
2.6.4 Security Settings.....	14
2.6.5 Language and Input Method Setting.....	14
2.6.6 Shortcuts.....	15
2.6.7 Widgets.....	15
3. Call Function.....	16
3.1 Making a Call.....	16
3.2 Contacts.....	17
3.3 SMS and MMS.....	18
3.4 Email.....	18
4. Network Connection and Connection.....	20
4.1 Wi-Fi Network Connection.....	20
4.2 Bluetooth.....	20
4.3 GPS.....	22
4.4 Connecting the Nautiz X2 to a PC.....	22
4.5 Synchronization.....	23
5. Enabling the Scan Function.....	24
6. Enabling the NFC Function.....	25
7. Managing the Nautiz X2.....	26
7.1 Installing Applications.....	26
7.2 Uninstalling Applications.....	26
7.3 Managing Applications.....	27
8. Precautions and Troubleshooting.....	28
8.1 Precautions.....	28

8.2 Troubleshooting..... 29
Appendix..... 31

1. INTRODUCTION

1.1 Appearance of Nautiz X2

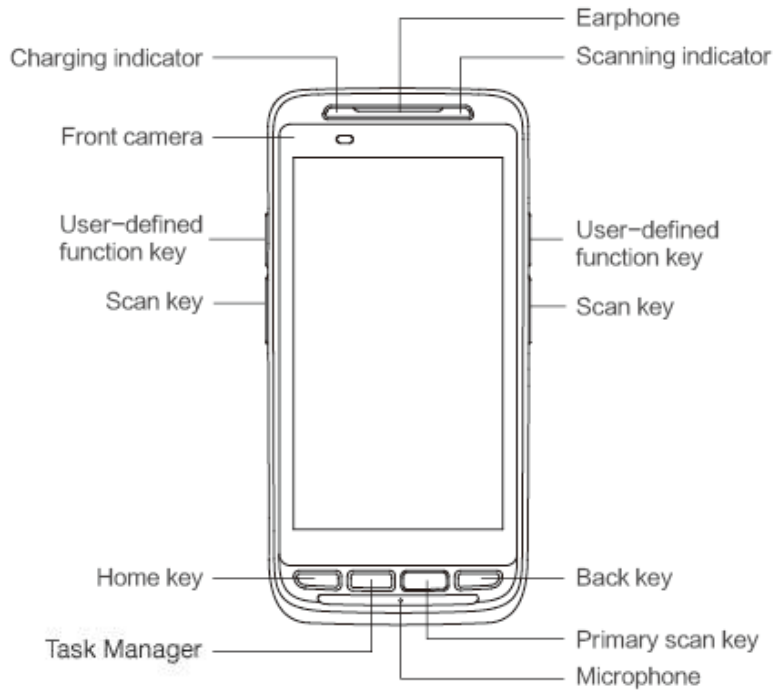

FIGURE 1-1 FRONT VIEW OF NAUTIZ X2

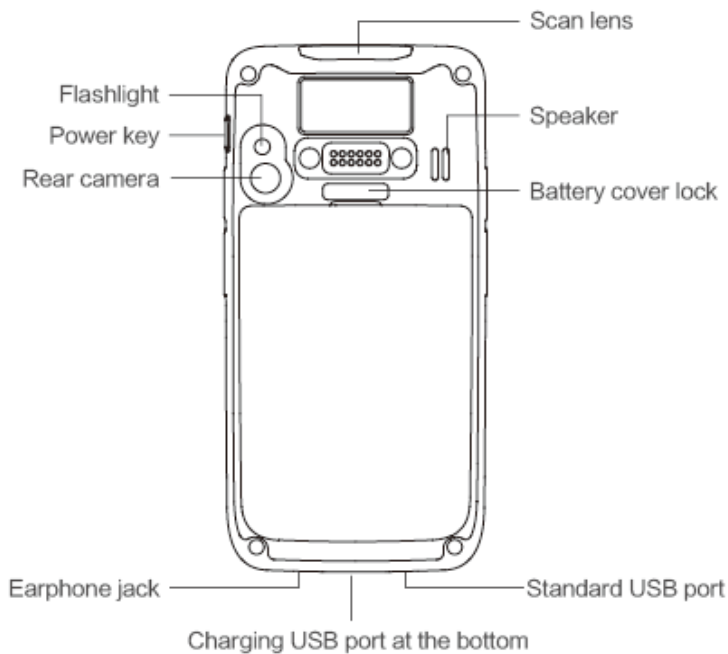
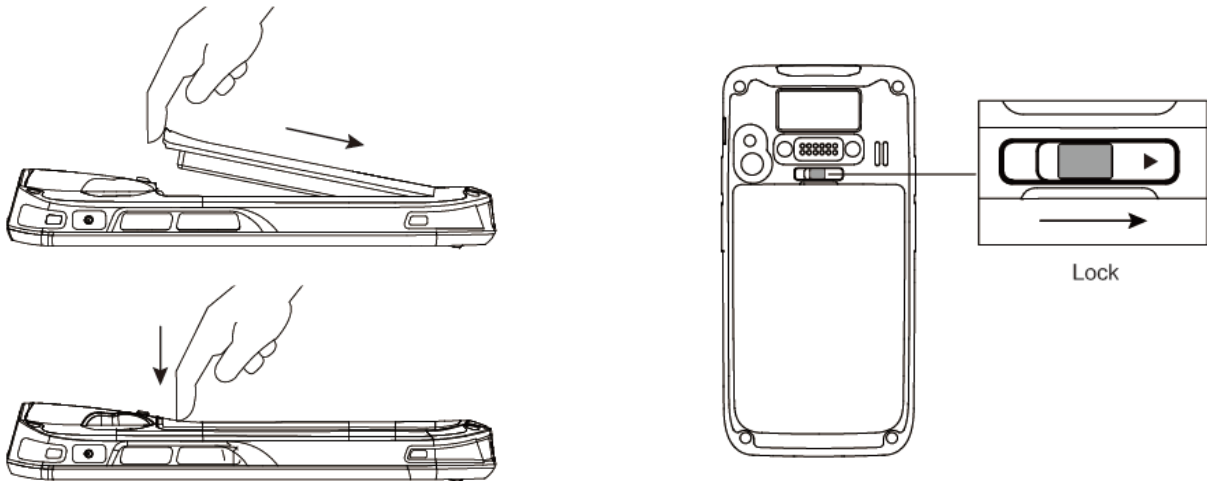

FIGURE 1-2 REAR VIEW OF NAUTIZ X2

1.2 Installing the Battery

1. Push the battery to the bottom of the battery compartment and press it downwards.
2. **Push the battery cover lock to the right to lock the battery cover.**



1.3 Removing the Battery

1. Push the battery cover lock to the left.
2. Pull up the battery cover from the groove at the upper end of the battery cover.

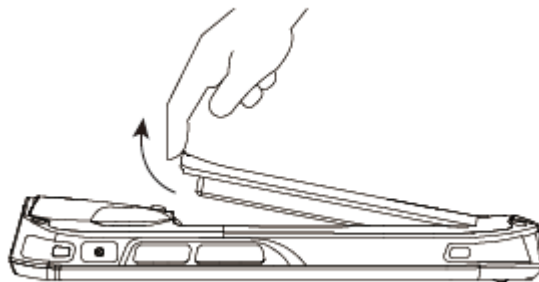

NOTE: The Nautiz X2 adapts integrated design for the battery and battery cover.

1.4 Inserting a SIM Card

Insert a SIM card by following the direction in the figure below.

NOTE: Micro SIM cards are applicable to the Nautiz X2. After replacing a SIM card, restart the Nautiz X2.

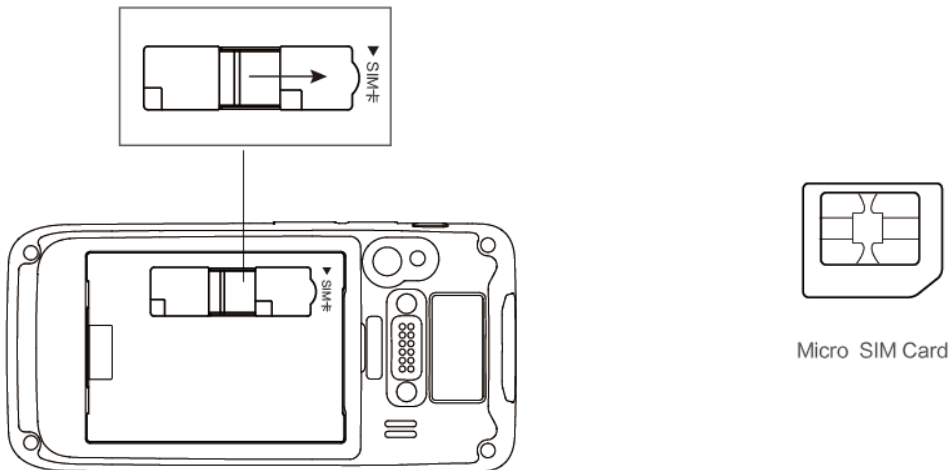

1.5 Inserting a TF Card

1. Push the card cover by following the OPEN direction marked on the card cover.
2. Open the card cover upwards and insert a TF card, as shown in the figure below.

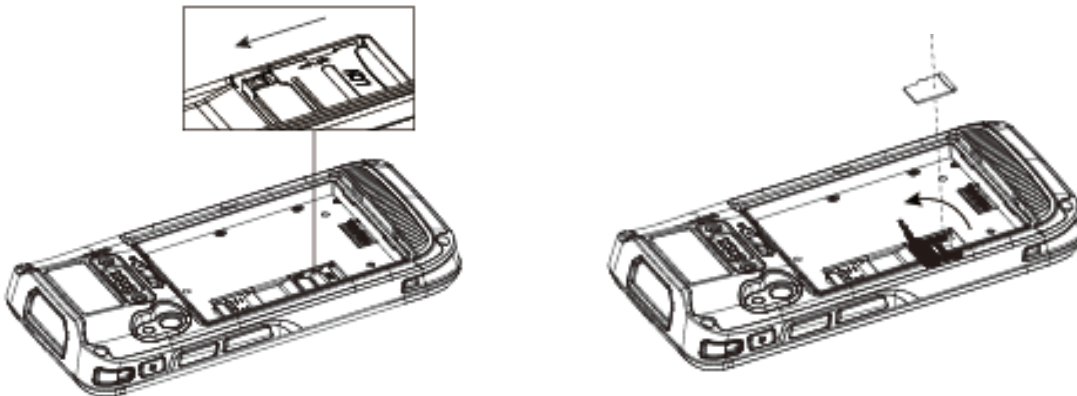

3. Close the card cover, as shown in the figure below.
4. Pull back the card cover by following the LOCK direction marked on the card cover.

NOTE: TF cards, namely Micro SD cards, are applicable to the Nautiz X2. After replacing a TF card, restart the Nautiz X2.

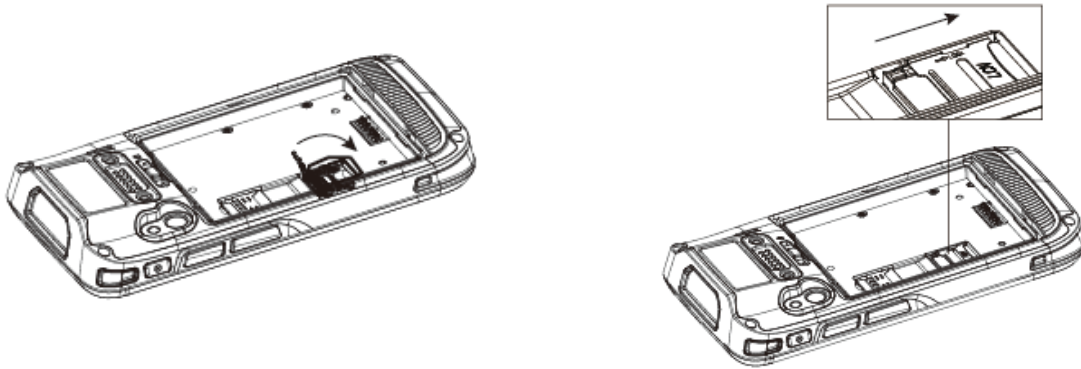

1.6 Charging

You can charge a battery in the following ways:

1. Bottom charging cable;
2. 1-slot charging & communication stand (to be purchased separately).



Bottom charging cable



1-slot charging & communication stand

Description of charging indicator:

When the battery is in the charging status, the charging indicator is in red.

When the battery is fully charged, the charging indicator is in green.

When the battery volume is low:

1. A message indicating that the battery volume is less than 20% is displayed on the screen.
2. The Nautiz X2 gives out a low battery prompt tone.
3. The charging indicator blinks in red.

The following operations can help obtain a longer standby duration of the Nautiz X2.

Shorten the time to sleep by selecting Settings > Display > Sleep.



Set the screen brightness to a small value by selecting Settings > Display > Brightness.

Disable functions that are not frequently used, for example, GPS, Bluetooth, Wi-Fi and 3G communication.

2. USING THE NAUTIZ X2

2.1 Powering On/Off the Nautiz X2

After installing a SIM card and a battery and charging the Nautiz X2 completely, you can use the Nautiz X2.

1. To power on the Nautiz X2, press the On/Off key  on the right for some time. The Nautiz X2 vibrates, displays the startup screen and enters the Android OS after the guide progress is complete. It takes some time for the Nautiz X2 to initialize. Please wait patiently.
2. To power off the Nautiz X2, press the On/Off key on the right  for some time. A dialog box that provides shutdown options is displayed. Click Power Off.

2.2 Locking and Unlocking the Nautiz X2

Locking the Nautiz X2

Press the On/Off key  momentarily to lock the Nautiz X2. If you do not perform any operation for the Nautiz X2 within the default locking time, the Nautiz X2 is automatically locked.

Unlocking the Nautiz X2

Press the On/Off key  momentarily and slide the unlock key to the right on the screen.



2.3 Keys

The Nautiz X2 provides a physical keypad that consists of four keys, as shown in the figure below.

On the physical keypad of the Nautiz X2, keys are respectively home key, multitask key, scan key, and back key from left to right.

Home key: used to go back to the home screen.

Task manager: used to switch between / close running apps.

Scan key: used to scan.

Return key: used to return to the previous operation screen.



2.4 Home Screen



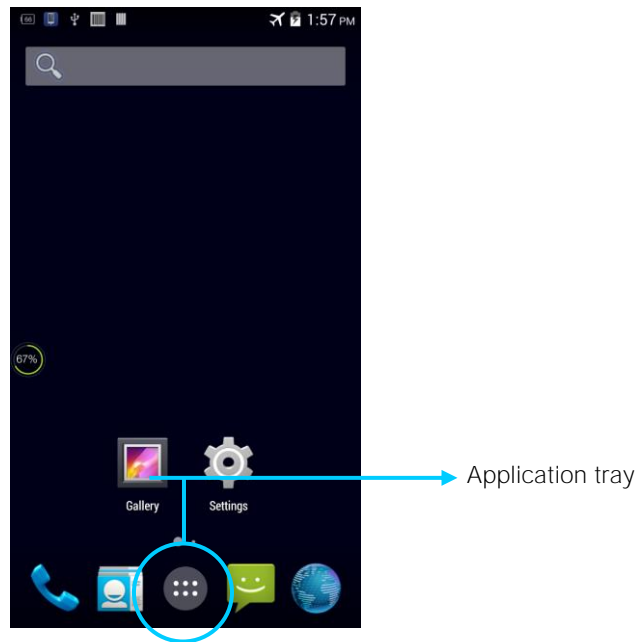









By default, the Nautiz X2 has one home screen. You can add home screens by placing applications to the home screen and slide to the left or right to switch to another home screen. On the home screen, click the icon of any application to open the application.



- You can freely add or delete the icon of an application in the blank of the home screen.
- If you click the application tray, all applications can be viewed.

2.5 Status Icons and Indicators

Status icons and indicators are in the status bar at the upper part of the screen and show device status and notifications.

Icon	Description	Icon	Description
	WLAN		Signal strength
	Bluetooth		Flight mode
	USB connection		Network access restricted
	Missed calls		USB debugging
	New messages		Charging
	Modem logs		Battery full
	Silent mode		Multiple notification icons, which are beyond the scope of display
	Application permission		EDGE
	Connection between USB and PC pea pod		

NOTE: As software is upgraded continuously, status indicators may be different from those displayed on the Nautiz X2. The actual status indicators prevail.

2.6 Basic Settings

2.6.1 Date and Time Settings

To change the date and time in the Nautiz X2, do as follows:

1. Find the following icon.



2. Select Settings > Date & time > Set date or Set time.

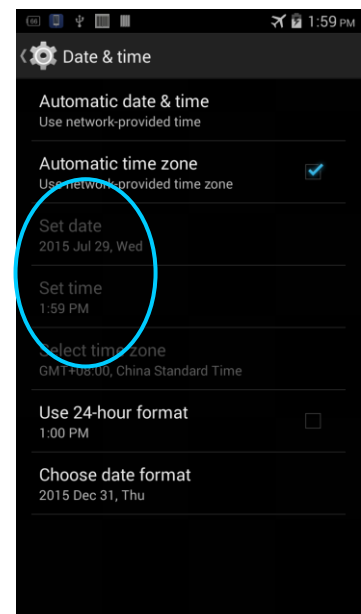
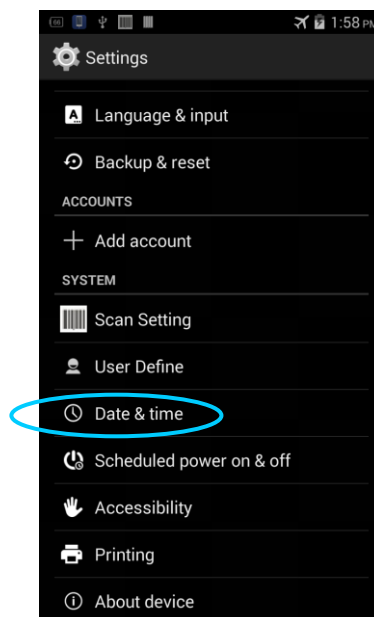
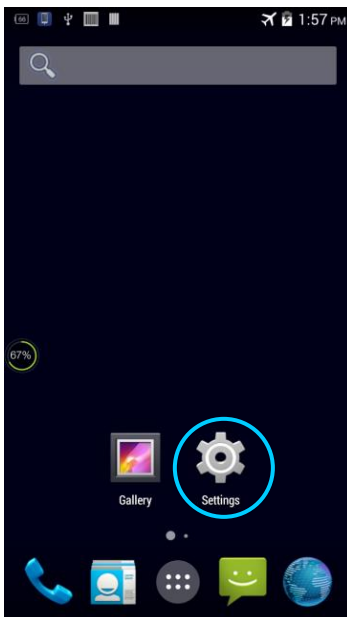

2.6.2 Display Settings

1. Find the following icon.



2. Select Settings > Display > Lock screen notification/Wallpaper/Brightness/Auto-rotate screen/Sleep/Interactive screensaver/Font size/Cast screen.

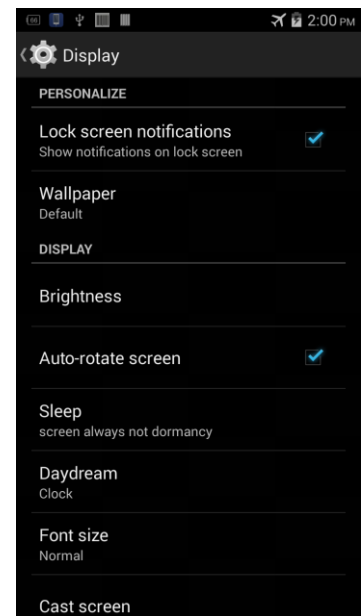
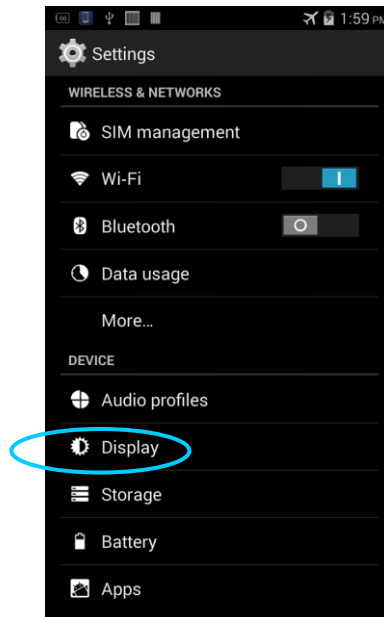
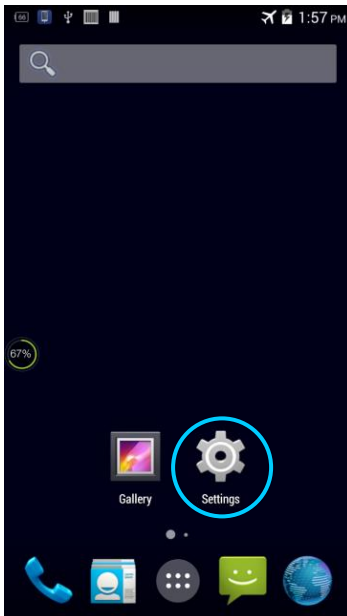

2.6.3 Ringtone Settings

1. Find the following icon.



2. Select Settings > Audio profiles > General/Silent/Meeting/Outdoor. Click different modes and set the ringtone in the modes.

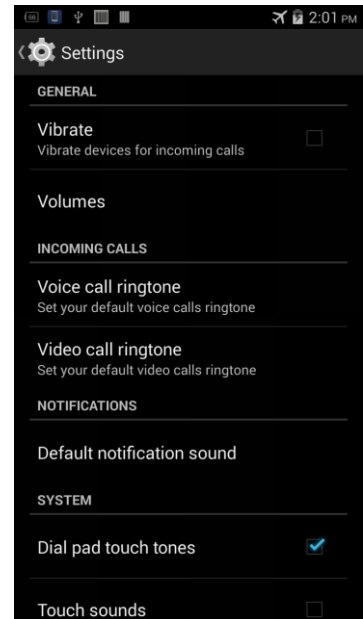
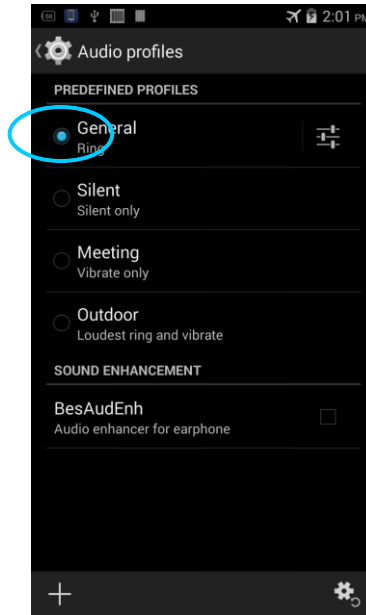
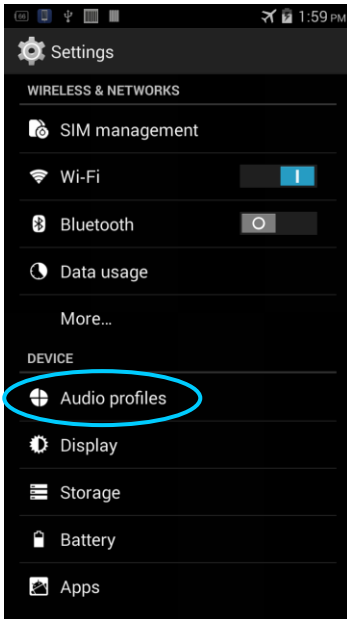

2.6.4 Security Settings

1. Find the following icon.



2. Select Settings > Backup & reset > Factory data reset.

The Nautiz X2 starts to restore factory settings.

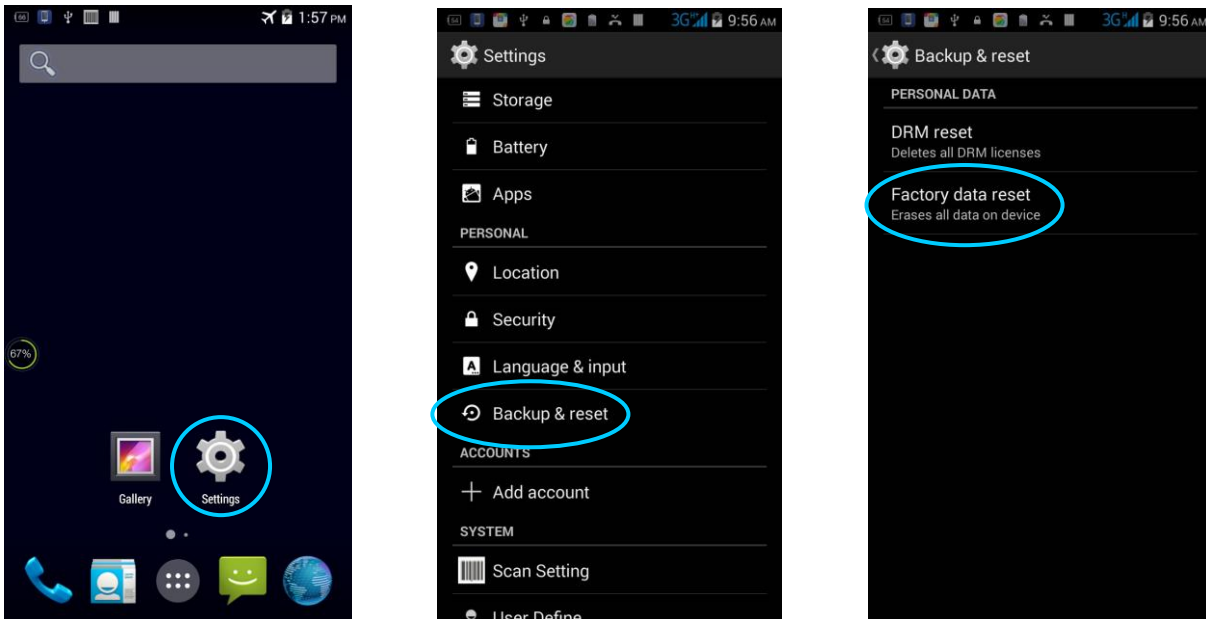

If you perform the preceding operation, the following data will be cleared:

- Account
- Data and settings of the system and applications
- Downloaded applications

The following data will not be cleared:

- Current system software and bound applications
- Files in the SD card, for example, music and photos

2.6.5 Language and Input Method Setting

1. Find the following icon.



2. Select Settings > Language & input, click Language, select a language, click Default, and select an input method.

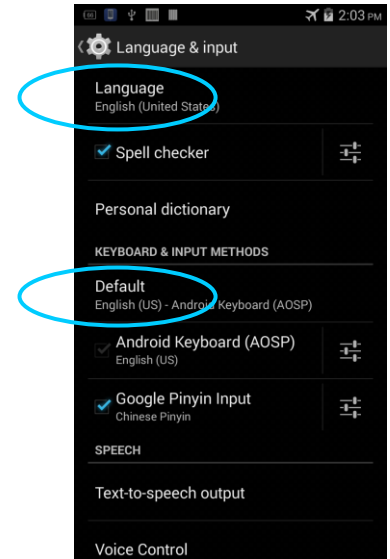
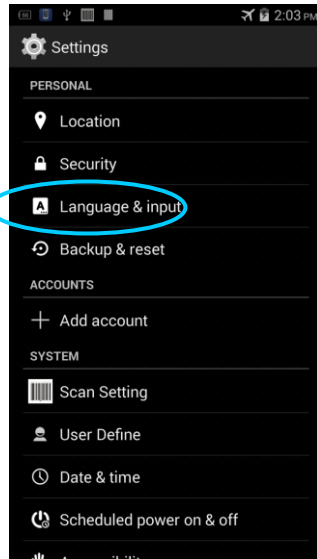
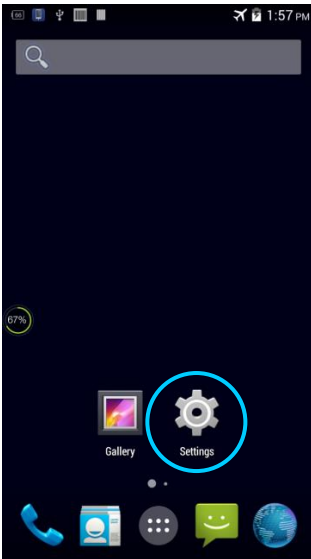

2.6.6 Shortcuts

You can add shortcut icons on the home screen of the Nautiz X2.

On the home screen, click the icon of application tray, press and hold an icon and drag it to the home screen.

2.6.7 Widgets

You can add widgets such as clock, music player and calendar on the home screen of the Nautiz X2.

On the home screen, press and hold a blank space. The entry for setting wallpaper and widgets is displayed. Click a widget and drag it to a blank space.

Click the icon of a widget to open the widget.

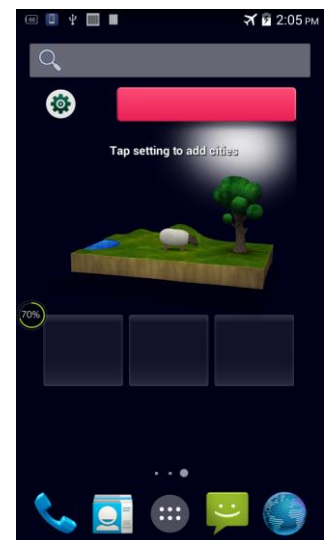
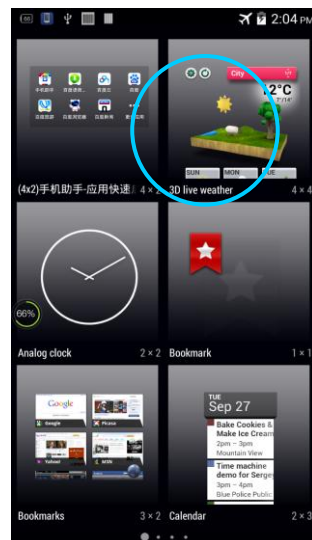
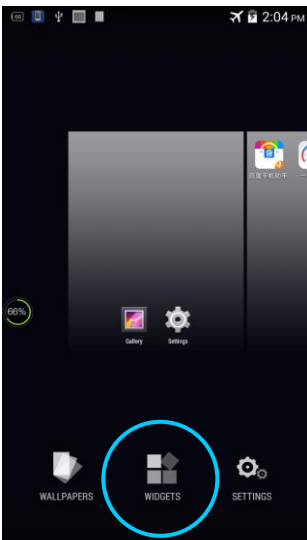

3. CALL FUNCTION

3.1 Making a Call

1. Find the following icon.
2. Enter a phone number.
3. To make a call.
4. To terminate the call.

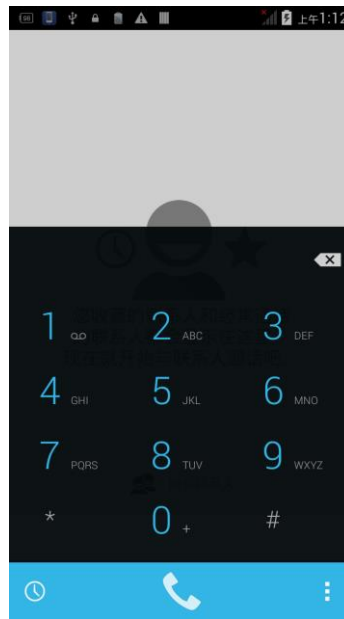
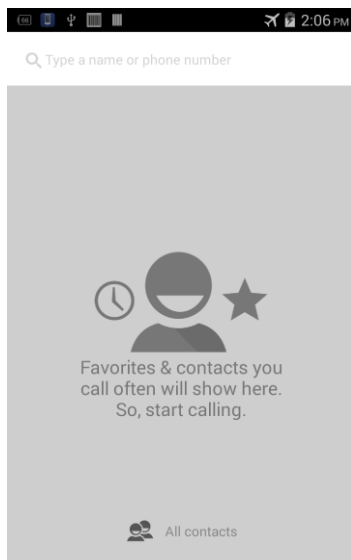

Call records ←

Keypad for dialing ←

Contacts ←

→ Voice call

3.2 Contacts

1. Find the following icon.



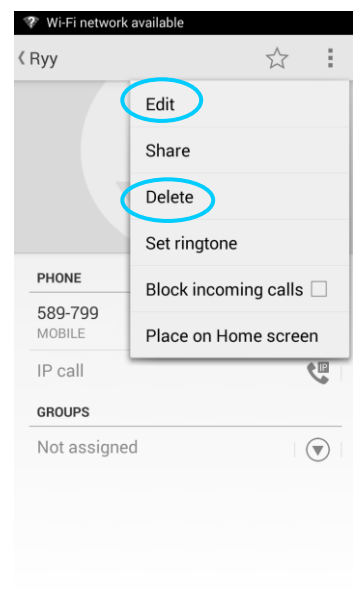
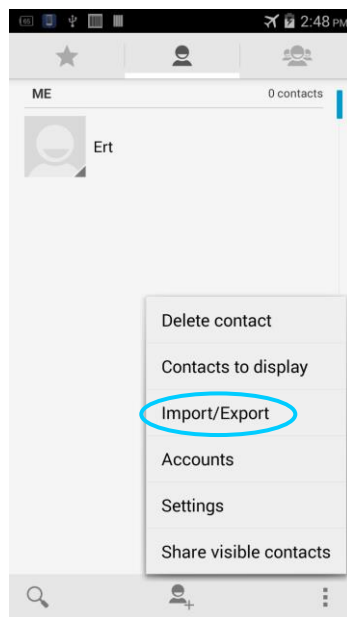
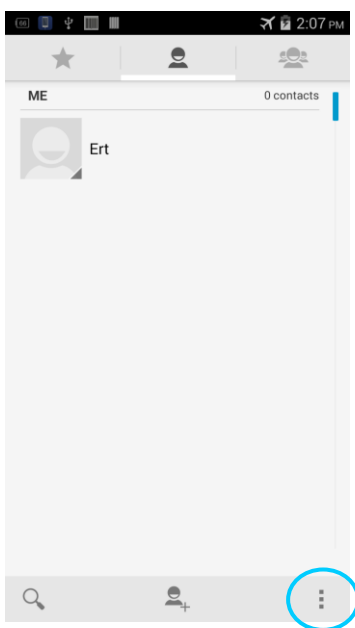

2. Click Contacts to open the list of contacts.
3. To add a contact, click -> 
4. To import or export contacts, press the menu key and click Import/Export.
5. To edit or delete a contact, select the contact, press the menu key and click Edit/Delete



3.3 SMS and MMS

1. Find the following icon.



2. Click  enter a receiver and text to be sent.
3. Click  to send the message.
4. On the message editing page, press the menu key, click Add subject to convert the message into a multimedia message. After editing the message, click  to send the message.

NOTE: Click  to add attachments such as photo, video and audio.

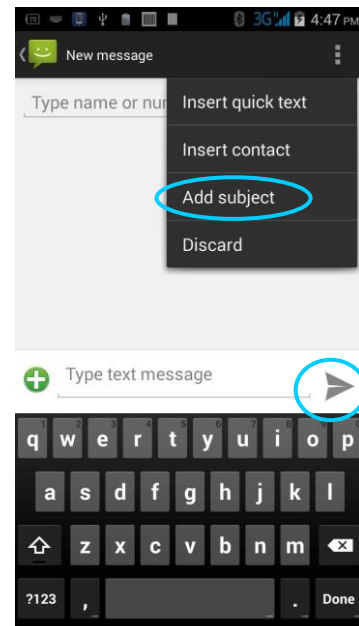
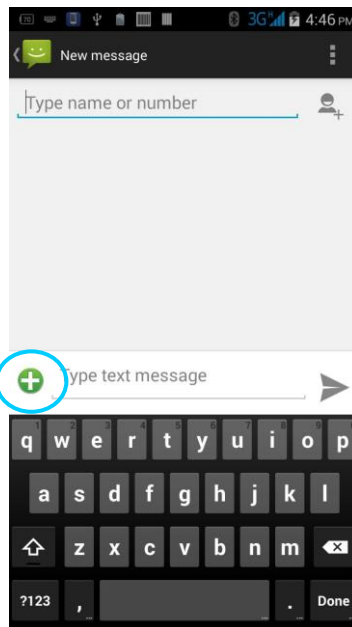
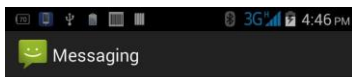

3.4 Email

You can send or receive emails.

1. Find the following icon.



2. Enter an email address and password and click Next.
3. Set Inbox checking frequency and click Next.
4. Create a name for the account and click Next. The email receiving page is displayed.

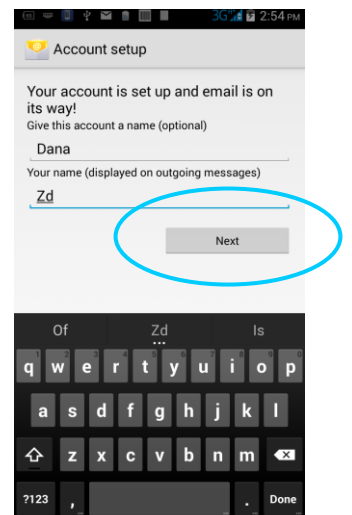
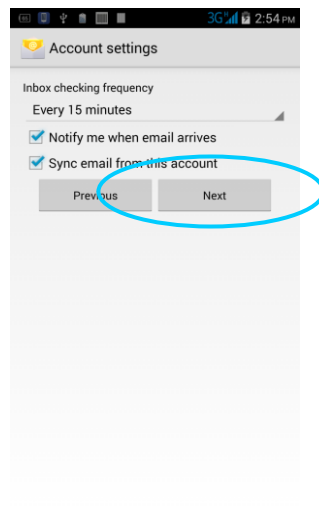
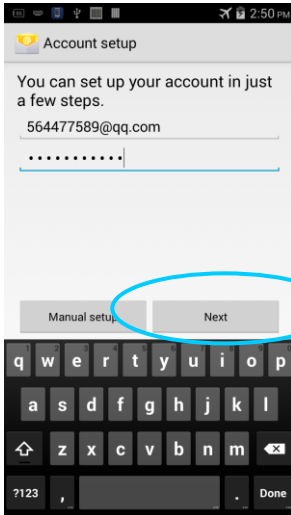

To synchronize or delete an account, do as follows:

1. On the home screen, click Settings.
2. Under the ACCOUNTS option, click POP3 to open added accounts and click the name of an account to be synchronized or deleted. On the Sync page, click in  the upper right corner and select Sync now or Remove account.

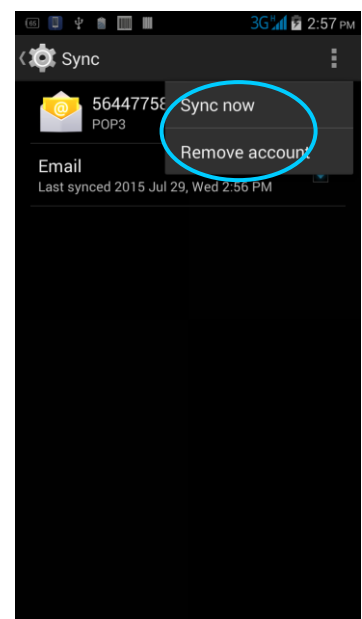
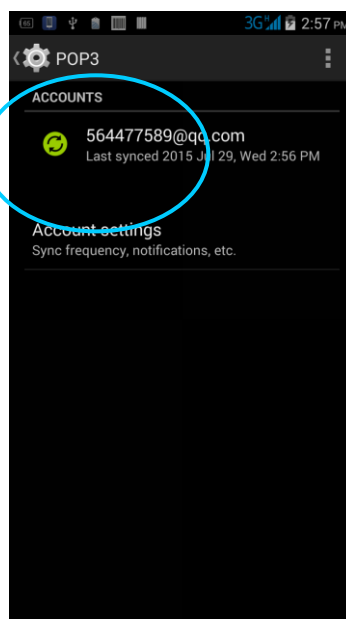
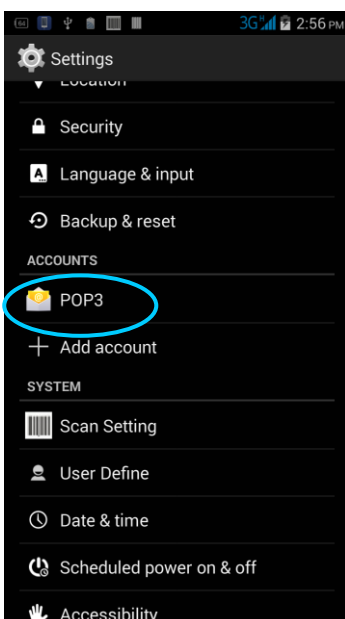

4. NETWORK CONNECTION AND CONNECTION

4.1 Wi-Fi Network Connection

1. Find the following icon.



2. Select Settings > WIRELESS & NETWORKS > WLAN.
3. Click Enable/disable WLAN. The Nautiz X2 starts to search for networks. If WLAN is enabled, click Scan. The Nautiz X2 lists networks in the range of search.
4. Click a network and enter the password in the dialog box that is displayed.
5. Click Connect. The Wi-Fi connection is completed.

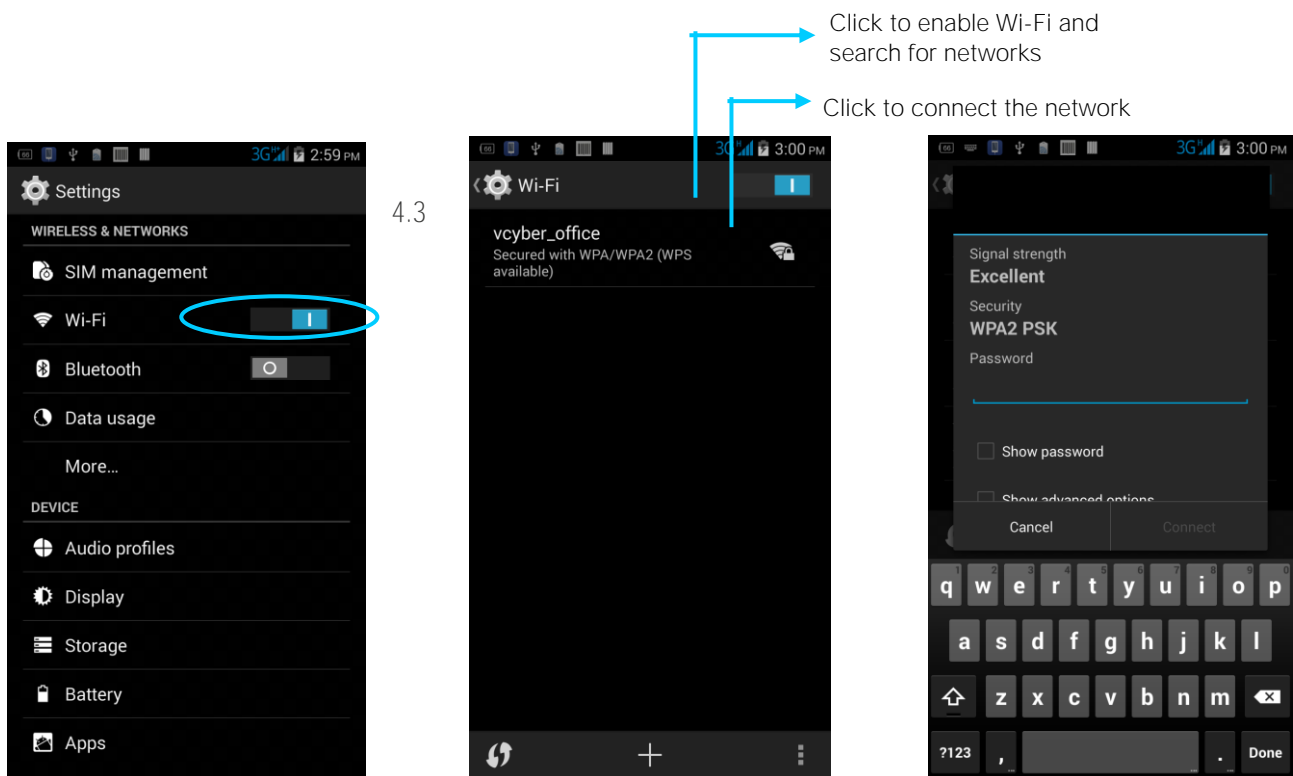

4.2 Bluetooth

After you enable the Bluetooth function on the Nautiz X2, you can establish wireless connections with other Bluetooth devices such as computers and mobile phones. In the scope without solid obstacles, the effect of Bluetooth connections is good.

1. Find the following icon.



2. Select Setting > WIRELESS & NETWORKS > Bluetooth.
3. Click the icon for enabling/disabling Bluetooth to enable Bluetooth and search for other Bluetooth devices.
4. In the list of searched devices, click a device to pair the device.

5. In the dialog box that is displayed, confirm the PIN and click Pair to connect the device.

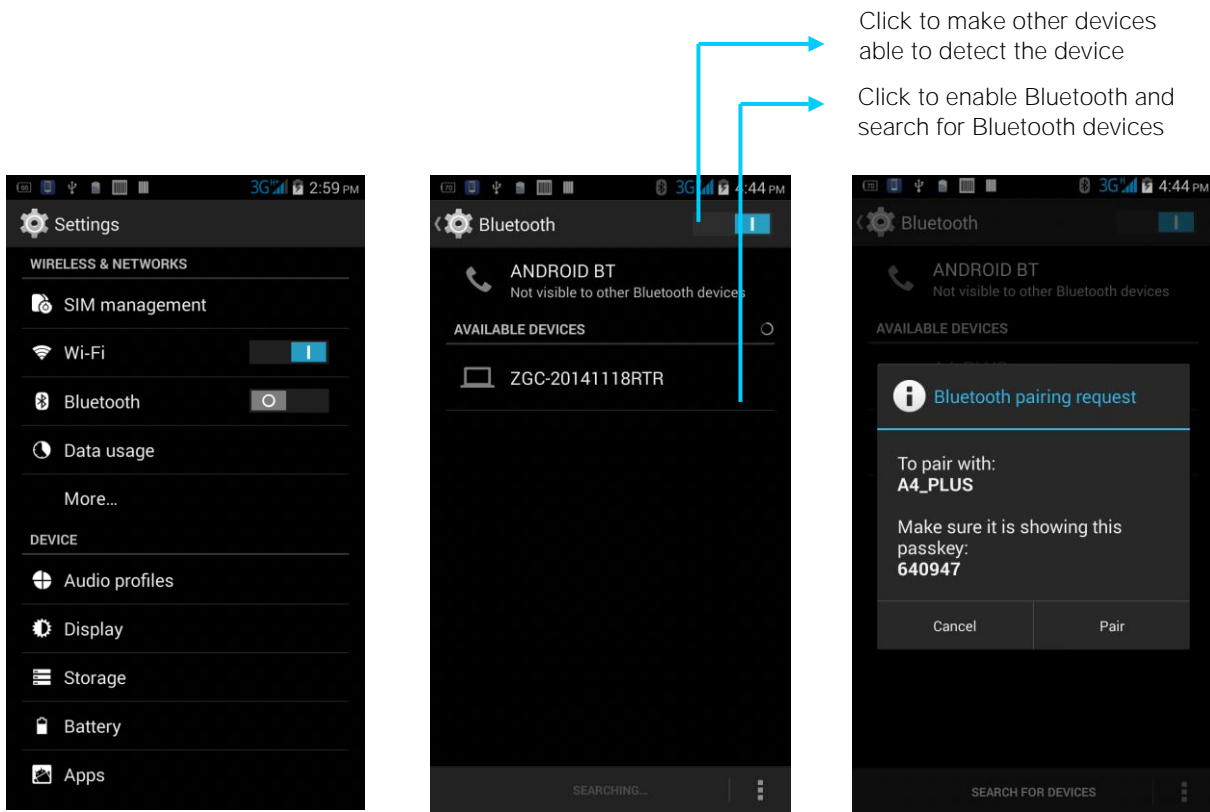

6. Click  on the right of a paired device. The Rename, Unpair and Internet access options are displayed. Perform operation as required.

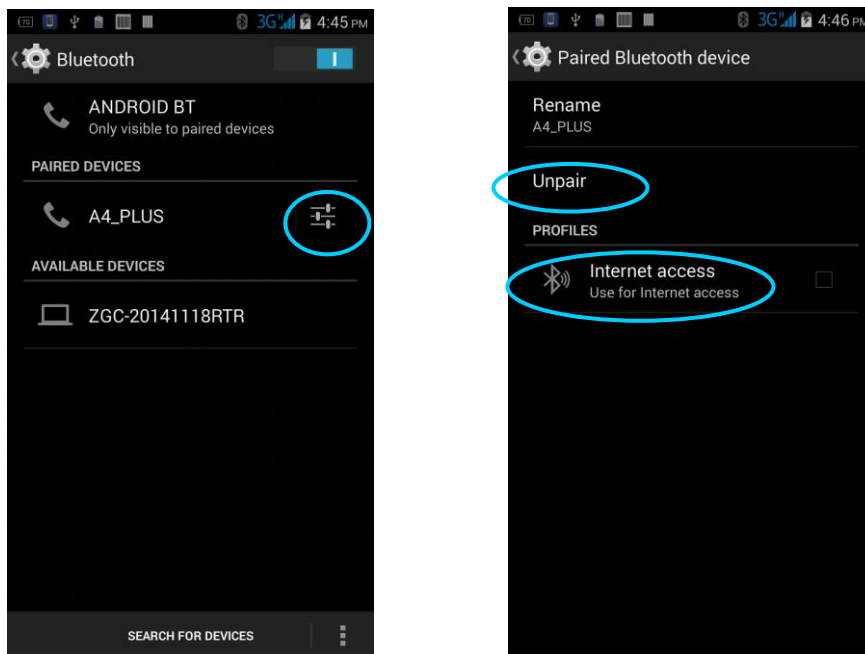



CAUTION

- Ensure that the device to be connected to the Nautiz X2 has enabled the Bluetooth function and Bluetooth visibility.
- During the connection process, set and pair the PIN. The Nautiz X2 does not support connection without a password.

4.3 GPS

The Nautiz X2 is equipped with a high-performance navigation chip and can quickly and accurately obtain position information. Handheld provides a GPS positioning demonstration program GPS Test.

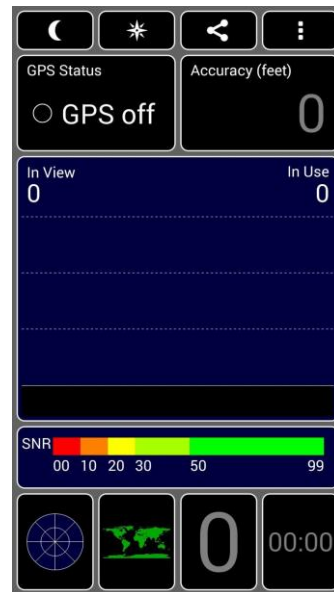
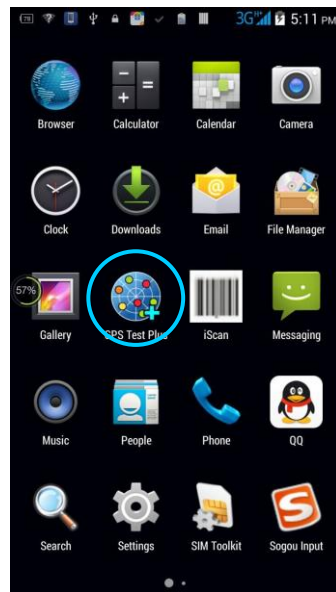

4.4 Connecting the Nautiz X2 to a PC

Connect the Nautiz X2 to a PC by using a USB data cable so that you can transmit and process files such as photo, video and music files between the memory card of the Nautiz X2 and the PC.

1. Connect the device to a USB port of the PC by using a USB data cable.
2. The status bar of the Nautiz X2 displays the USB connection icon. Slide downwards the status bar. The USB connection status can be viewed and the USB connection mode can be selected.

4.5 Synchronization

1. Find the following icon.



2. Select Settings > Accounts & sync.
3. Click Add account to set a new account.
4. Select Company or Email, enter the email address and password, click Next and wait until the connection is **complete** (for details about email setting, see 3.4 "Email").
5. Click Accounts. On the synchronization setting page, perform setting as required.

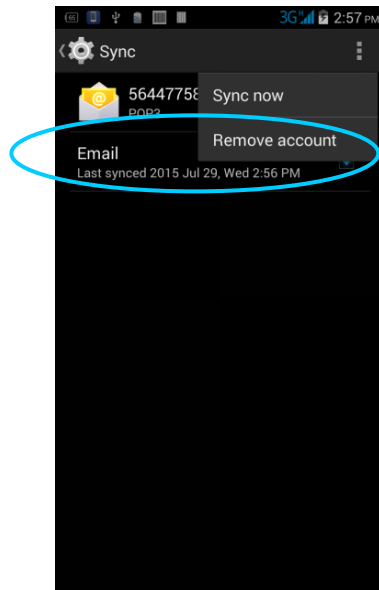

5. ENABLING THE SCAN FUNCTION

1. Click the iScan icon on the menu page.
2. Click the blue slider on the right of Enable Barcode Scanning to enable the scanning function (if you click the slider again, the scanning function is disabled).
3. Press the front or side scan keys to scan a barcode. When the scanning indicator becomes green from red and a beep is heard, the barcode is scanned successfully.

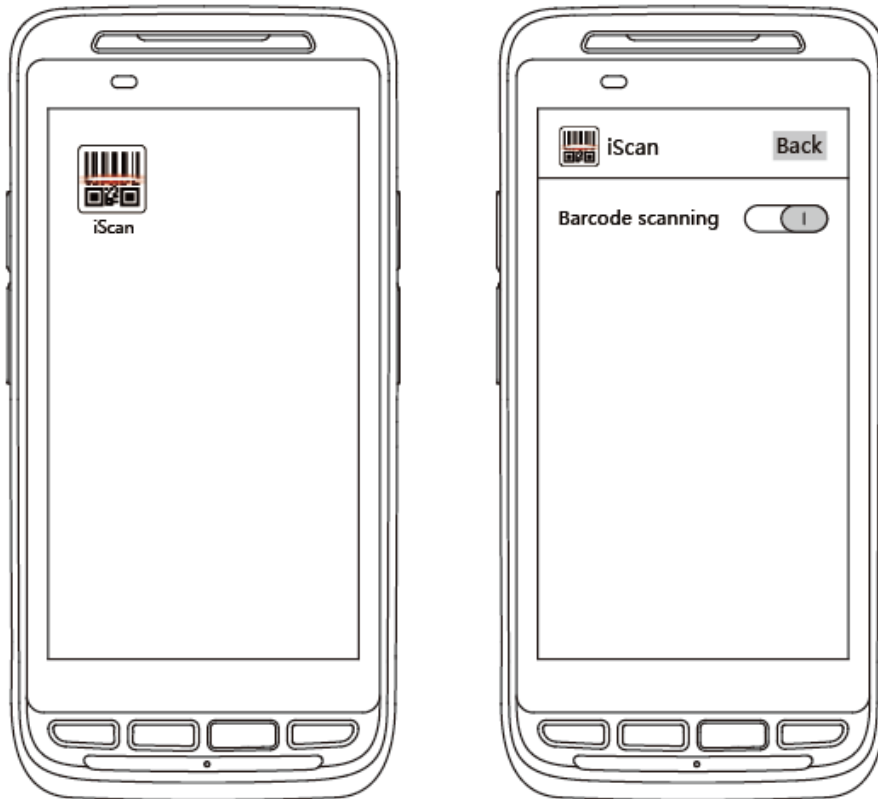

NOTE: iScan is used to scan barcodes. By default, iScan is installed and scanning is enabled upon delivery of the device.

6. ENABLING THE NFC FUNCTION

1. Click the Settings icon on the menu page.
2. Wireless & Networks -> More -> NFC
3. Click the slider on the right to enable NFC (if you click the slider again, NFC is disabled).
4. Put an NFC card close to the back of the Nautiz X2. After a beep is heard, the card is read successfully.

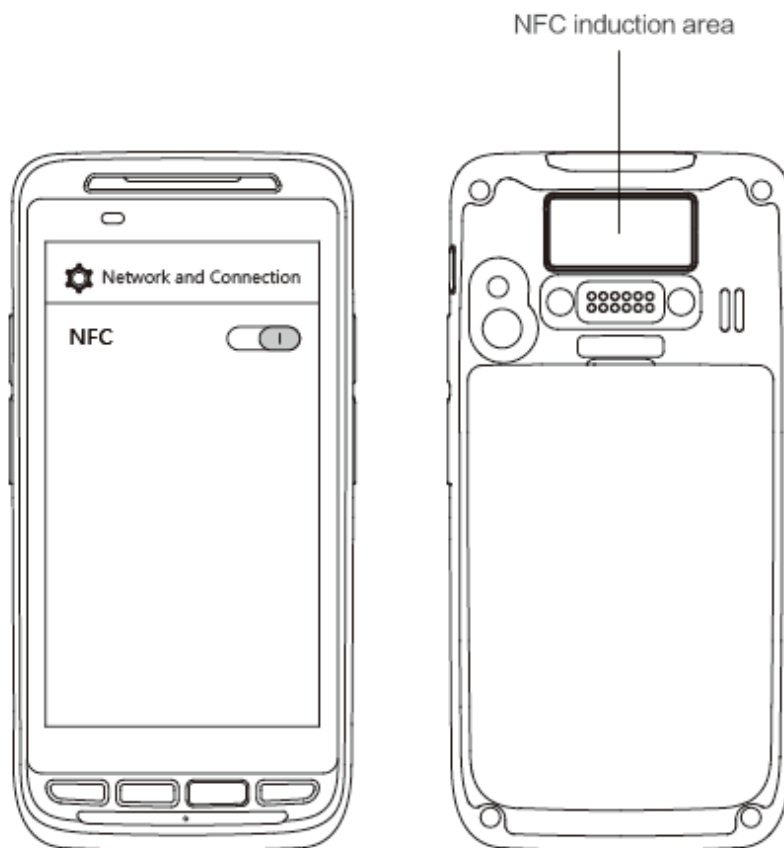

7. MANAGING THE NAUTIZ X2

7.1 Installing Applications

The Nautiz X2 uses Google Android OS, where the suffix of Android software is apk. To install programs on the Nautiz X2, use the following methods:

1. Download software at the online software store (Google Play) provided by Google.
2. Download software installation packages, store them on the SD card and install the software through file manager.
3. Connect the Nautiz X2 to a PC by using a USB data cable and install software for the Nautiz X2 on the PC.

7.2 Uninstalling Applications

If too many programs are installed or some programs are unnecessary, uninstall programs to improve the running speed of the Nautiz X2. To uninstall a program, do as follows:

1. Select Settings > App. In the application list that is displayed, select an application and click it. On the page for uninstalling the application, click Uninstall and then click OK. Wait several seconds until the application is uninstalled.
2. Click the application tray. On the application screen, find the icon of an application, press and drag the icon to the dustbin to uninstall the application.

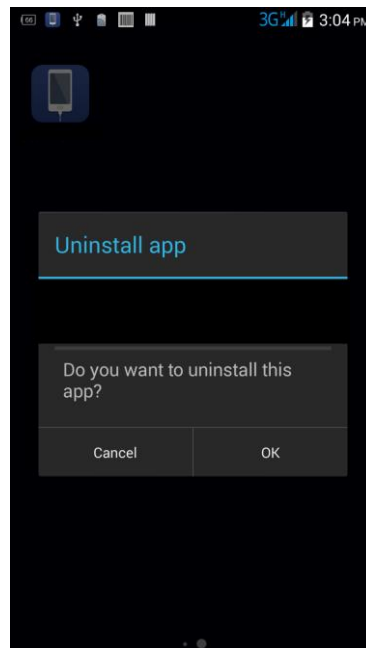
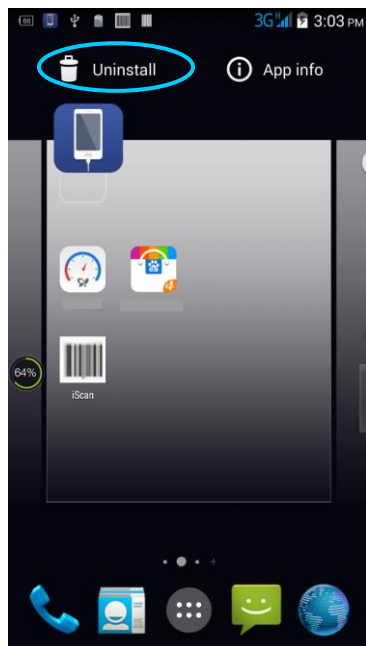

7.3 Managing Applications

Select Settings > App. On the application management screen, you can view application status in the options such as Downloaded, SD Card and Running, click an application, access the application information screen, and perform operations such as forcibly stopping, uninstalling and stopping an application.

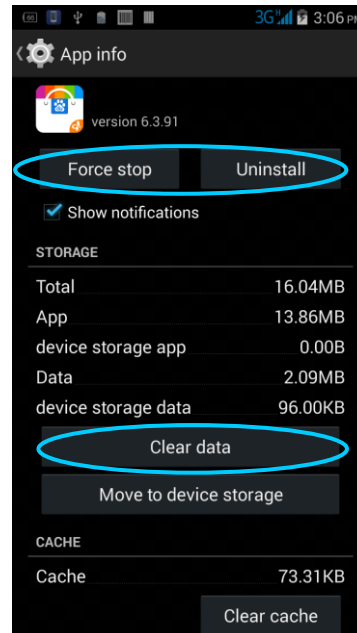
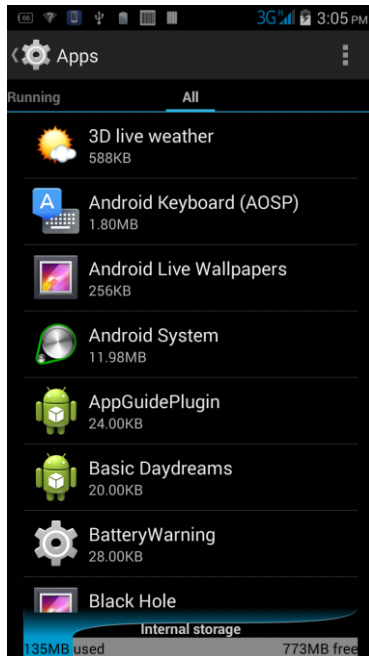

8. PRECAUTIONS AND TROUBLESHOOTING

8.1 Precautions

- Put the Nautiz X2 and its components and accessories in the places where children cannot reach.
- Keep the Nautiz X2 dry. Rain, moisture and liquid contain acidic materials and will corrode the circuit board.
- Do not store or use the Nautiz X2 in dusty or dirty places.
- Do not store the Nautiz X2 in a place that is too hot. High temperature will shorten the service life of electronic components.
- Do not store the Nautiz X2 in a place that is too cold. When the temperature inside the Nautiz X2 rises, moisture is generated inside the Nautiz X2, which may damage the circuit board.
- Do not try to disassemble the Nautiz X2. Otherwise, the Nautiz X2 may be damaged.
- Do not touch the screen surface of the Nautiz X2 by using a pen, a pencil or other sharp articles in case the screen may be scratched.
- Do not throw, beat or violently collide the Nautiz X2. Otherwise, the components of the Nautiz X2 may be damaged and the Nautiz X2 may be faulty.
- Do not use strong chemical products or strong detergent to clean the Nautiz X2. If the Nautiz X2 become dirty, clean the surface of the Nautiz X2 by using a soft cloth soaked with dilute glass detergent.
- Please use the protective film to reduce wear as much as possible. The screen protective film can improve the availability and durability of the screen.

Pay attention to the following during use of the battery:

- The area where the Nautiz X2 is charged must keep away from scraps, inflammables or chemical substances.
- When you charge the battery of a mobile device, the temperature on the battery and charger must be in the range 0°C to 40°C.
- Do not use incompatible batteries or chargers, which may cause fire, explosion, leakage or other hazards.
- Do not disassemble, press, twist, pierce or cut the battery.
- Do not make the battery short-circuited or contact the connecting terminal of the battery by using metal or other conductive objects.
- Do not insert other materials into the battery, contact the battery with water or other liquid, or expose the battery in an open fire, explosive source or other sources of danger.
- Do not put or store the battery in the environment where the temperature is too high.
- Do not put the battery in a microwave oven or a drying machine.
- Do not put the battery into a fire.
- If the battery leaks, do not let the liquid stain your skin or eyes. Otherwise, wash your skin or eyes with lots of water and go to see the doctor immediately.

Cleaning Nautiz X2

- Clean the shell by using a cloth soaked with alcohol, including keys and space between keys.
- You can clean the display screen by using a cloth soaked with alcohol. Do not let the liquid gather around the screen. Otherwise, dry the screen by using a soft non-woven cloth in case strip marks are left on the screen.
- Clean the scan lens regularly by using lens paper or other articles suitable for cleaning optical materials.

8.2 Troubleshooting

TABLE 8-1 NAUTIZ X2 TROUBLESHOOTING

Fault	Cause	Solution
After the power key is pressed, the Nautiz X2 is not powered on.	The battery volume is too low or the battery is not charged.	Charge the battery or replace the battery.
	The battery is incorrectly installed.	Correctly install the battery.
	The system breaks down.	Restore factory settings.
The rechargeable battery can no longer be charged.	The battery fails.	Replace the battery.
	The temperature of the battery is too high or low.	Put the battery in normal temperature.
During data communication, data is not transmitted or transmitted data is incomplete.	The cable configuration is incorrect.	Consult the system administrator.
	The communication software is incorrectly installed or configured.	Install or reinstall the synchronization software to update the driver.
The relevant function is not activated after a user clicks a button or icon.	The system does not respond.	Restart the system.
No sound can be heard.	The volume is too low or is disabled.	Adjust the volume.
The Nautiz X2 is closed.	The Nautiz X2 is in the inactive state.	After being inactive for a period of time, the Nautiz X2 is locked.
	The battery is used up.	Replace the battery.
The Nautiz X2 responds at a low speed.	Too many files are stored in the Nautiz X2.	Remove unused memos and records. If necessary, save the records on the host or increase the storage capacity by using an SD card.
	Too many applications are installed on the Nautiz X2.	Remove applications installed on the Nautiz X2.
The Nautiz X2 cannot decode a barcode while reading it.	The scan application is not loaded.	Load the scan application in the Nautiz X2.
	Reading a barcode fails.	Check that the barcode is indefective.
	The battery volume is low.	If the scanner stops sending out a light beam after you press the trigger switch, check the battery volume.

TABLE 8-2 BLUETOOTH TROUBLESHOOTING

Fault	Cause	Solution
The Nautiz X2 cannot detect any Bluetooth device nearby.	The Nautiz X2 system is too far away from other Bluetooth devices.	Move the Nautiz X2 close to other Bluetooth devices, making the distance between them within 10 meters.
	The Bluetooth devices nearby are not enabled.	Enable the Bluetooth devices you are searching for.
	Bluetooth devices are in a mode that cannot be detected.	Set Bluetooth devices in a mode that can be detected.
When a user attempts to connect a Bluetooth phone to the Nautiz X2, the Bluetooth phone identifies the Nautiz X2 as the previously paired Nautiz X2.	The Bluetooth phone memorizes the name and address of the Nautiz X2 paired previously over Bluetooth.	Remove the paired device and the name from the Bluetooth phone.
A Bluetooth device can be detected but cannot be connected.	The Nautiz X2 does not support connecting a Bluetooth device without a password.	Set a password for the Bluetooth device.

TABLE 7-3 CABLE TROUBLESHOOTING

Fault	Cause	Solution
Charging fails.	The cable is in poor contact.	Replace the cable.
Connecting to the Nautiz X2 fails.	The cable is in poor contact.	Replace the cable.

TABLE 7-4 WI-FI TROUBLESHOOTING

Fault	Cause	Solution
Connecting to an AP fails.	The message “Authentication failed” is displayed.	The password for the WLAN device is incorrect.

APPENDIX

TABLE 1 ACCESSORIES OF THE NAUTIZ X2

Component	Description
Nautiz X2	
Standard battery	
Power adapter	Used to charge the battery.
Bottom charging cable	
USB data cable	Used to communicate with the Nautiz X2 or charge the Nautiz X2.
Instructions	

TABLE 2 TECHNICAL SPECIFICATIONS OF THE NAUTIZ X2

Item	Nautiz X2
System configuration	
CPU	High-performance quad-core 1.3 GHz processor
Operating System	4G: Android 5.1
Memory	8 GB ROM+1 GB RAM
Expansion Slot	Mini SD card, up to 32 GB
Display	4.7- inch, 1280 x 720 High resolution
Touch Panel	Industrial-grade capacitive touch panel (supporting operation with gloves)
Camera (Optional)	8 MXP camera in the back side, autofocus lens, LED flash
Exit Window	Corning® Gorilla® glass
Keypad	4 front keys, 4 side keys , Power key
Battery	3.7 V 3600 mAh rechargeable lithium polymer battery
Audio	Built-in microphone /Mini USB/Headphone connector
Notification	Vibrator alerts/LED/Audio notification
Vibration Motor	Built-in programmable vibration motor
Structure parameters	

Item	Nautiz X2		
Dimensions (L x W x D)	150 mm x 73.5 mm x 16 mm (24 mm thick at the head)		
Weight	230g (including battery)		
Communication and transmission			
Wireless WAN	Nautiz X2 NA		Nautiz X2 EU
(Network frequency)	2G	850/900/1800/1900(Band 5/8/3/2)	850/900/1800/1900(Band 5/8/3/2)
	3G	UMTS/HSPA+ Primary bands 2/5. Roaming bands 8.	UMTS/HSPA+ Primary bands 1/8. Roaming bands 2/5
	4G	LTE Bands 2/4/5/17	LTE Bands 1/3/7/8/20
Wireless WAN (Data service)	4G: GPRS/ EVDO /WCDMA/ TD-LTE/LTE FDD/CDMA 1X		
Wireless LAN	4G: Wi-Fi 802.11a/b/g/n Dual-band Wi-Fi: 2.4G+5G)		
Bluetooth	Bluetooth 4.0		
GPS	Supporting GPS		
Operating environment			
Development tool	Android SDK+JDK+Eclipse		
Supported language	Java		
Operating Temp.	-10°C ~ 50°C (14°F to 122°F)		
Storage Temp.	-20°C ~ 60°C (-4°F to 140°F)		
Humidity	0 to 95% (non-condensing)		
Drop specification	Multiple drops to cement ground from a distance of 1.2m		
Sealing standard	IP65		
ESD	± 15 kV air discharge, ±8 kV direct discharge		
1D laser scanning engine			
Optical resolution	≥ 4 mil		

Item	Nautiz X2
Scan depth of field	3.81 cm to 60.98 cm
Scanning angle	47±3° (standard)
Scanning speed	102±12 times per second (two-way)
1D/2D image scanning engine	
Optical resolution	≥ 3 mil
Scanning angle	Omni-directional
Scanning speed	300 times per second
NFC	
Frequency	13.56 MHz
Reading distance	Within 10 mm
Communication protocol	ISO14443A
Input/output port	
USB Port	1 (Mini USB port)
Charger Port	1 (Charging interface at the bottom)
Headset Port	1

Power Adapter:
Manufacturer: SHENZHEN FUJIA APPLIANCE CO.,LTD.
Model: FJ-SW1260502000UE
Input: AC 100-240V; 50/60Hz;0.4Amax
Output: DC5.0V;2000mA

Battery:
Model: 1ICP9/65/85
Capacity:3300 mAh 12.2Wh
Nominal Voltage:DC 3.7V
Maximum Charge Voltage:DC 2.4V

CE marking:



CAUTION

RISK OF EXPLOSION IF BATTERY IS REPLACED BY AN INCORRECT TYPE. DISPOSE OF USED BATTERIES ACCORDING TO THE INSTRUCTIONS.



To prevent possible hearing damage, do not listen at high volume levels for long periods.

Fully understand user manual before use.

Ensure your player at low volume levels or power off before you leaving.

Statements

Changes or modifications not expressly approved by the party responsible for compliance could void the user's authority to operate the equipment.

This equipment has been tested and found to comply with the limits for a Class B digital device, pursuant to Part 15 of the FCC Rules. These limits are designed to provide reasonable protection against harmful interference in a residential installation. This equipment generates, uses and can radiate radio frequency energy and, if not installed and used in accordance with the instructions, may cause harmful interference to radio communications. However, there is no guarantee that interference will not occur in a particular installation.

If this equipment does cause harmful interference to radio or television reception, which can be determined by turning the equipment off and on, the user is encouraged to try to correct the interference by one or more of the following measures:

- Reorient or relocate the receiving antenna.
- Increase the separation between the equipment and receiver.
- Connect the equipment into an outlet on a circuit different from that to which the receiver is connected.
- Consult the dealer or an experienced radio/TV technician for help.

This equipment complies with FCC radiation exposure limits set forth for an uncontrolled environment. End user must follow the specific operating instructions for satisfying RF exposure compliance. This transmitter must not be co-located or operating in conjunction with any other antenna or transmitter.

The portable device is designed to meet the requirements for exposure to radio waves established by the Federal Communications Commission (USA). These requirements set a SAR limit of 1.6 W/kg averaged over one gram of tissue. The highest SAR value reported under this standard during product certification for use when properly worn on the body

handheld